

SANIKA



Installation and Maintenance Manual for SANIKA prefabricated bathrooms

User guide inside

SANIKA S.r.l.
Via Primo Maggio 22
38089 STORO TN
ITALY

It is not allowed to duplicate or reproduce this brochure or part of, without the prior written permission of SANIKA S.r.l.

SANIFLEX® and SANICLASS® are registered Trademarks of SANIKA S.r.l.

© All rights reserved.

Caution: This is a general instruction manual and as such will not cover all possible issues. For clarification and in case of problems during the installation, maintenance or use, please refer to our local distribution partner, or directly to us.



SANIKA disclaims all responsibility and guarantee in case of misuse of the bathroom and failure to comply with the instructions provided in this manual.

As each bathroom is different from the others, please examine the technical drawings closely.

Sanika reserves the right to make changes at any time without notice.



Quality Management System certified by TÜV Italia complying to the standard UNI EN ISO 9001:2000 - Certificate no. 50 100 6062

Index

| | |
|--|----|
| INTRODUCTION | 4 |
| GENERAL SAFETY INSTRUCTIONS FOR THE OPERATOR | 5 |
| PRODUCT SPECIFIC SAFETY INFORMATION | 6 |
| TRANSPORTATION AND STORING ON THE BUILDING SITE | 7 |
| INSERTION OF THE BATHROOM PODS IN A BUILDING | 10 |
| PREPARATION OF THE ASSEMBLY | 11 |
| SET-UP OF A COMPLETELY ASSEMBLED BATHROOM | 12 |
| SET-UP OF A PROVISIONALLY PRE-ASSEMBLED BATHROOM (IN ELEMENTS) | 13 |
| WATER CONNECTION | 16 |
| VENTILATION | 18 |
| ELECTRIC CONNECTION | 18 |
| MOUNTING OF THE OUTSIDE CLADDING | 20 |
| INSTALLATION OF ACCESSORIES | 21 |
| CLEANING AND CARE | 23 |
| PERIODIC MAINTENANCE | 24 |
| REPAIRS | 25 |
| SPARE PARTS | 26 |
| WARRANTY | 26 |
| MANUFACTURER | 27 |

Introduction

Dear Customer,

We wish to thank you for having bought one of our products.

You have purchased a high quality prefabricated bathroom, which is a compact and robust construction that fully satisfies the requirements of a modern bathroom. It is very stable despite its very low weight, due to innovative light weight construction.



The prefabricated bathroom with tiles, glass, marble...
100% individuality



The prefabricated bathroom made of GRP (glass fibre reinforced plastic) with a scratch-resistant and easy to clean surface

This document aims to give you instructions on the proper use and maintenance of the SANIKA prefabricated bathroom. The user guide inside this manual is part of the product and should always be at the operator and user's disposal.

For safety reasons and in order to prevent accidents, we advise you to read this instruction manual thoroughly.

Should problems arise, which are not described in this manual, please refer to our local customer service agent or directly to us, to get all the necessary information. We will be happy to help you.

This manual and the user guide are available also in German and Italian on our web page www.sanika.it

General safety instructions for the operator

For the safe use of the bathroom, it is necessary to keep to the following guidelines:

- **Follow the instructions in the user guide inside this manual and pass them to the final user as well.**
- Do not make any alterations to the prefabricated bathroom, neither by adding nor by subtracting any item (see the relevant chapter for exceptions). Unauthorised modifications are a potential safety risk and in no case SANIKA will accept responsibility for them.
- The positioning/assembly of the prefabricated bathroom and the connection of plumbing and electrics have to be done only by authorised and qualified personnel.
- Any repairs have to be carried out only by authorised engineers.
- Always use genuine parts as they are the only ones to satisfy technical standards and specifications. The use of non genuine parts does not ensure the optimal product safety and invalidates the product warranty.
- Safety notices always have to be clean and clearly visible. They must be neither covered nor removed. In case of damage or bad readability they must be replaced.
- In addition to the instructions explicitly given in this manual, which comply in particular with the European Regulations, in case of use of the bathroom in a non-EU state, the local laws and regulations will have to be observed as well.
- Do not remove any earth bonding points
- Always keep to the safety and maintenance instructions of the different accessories:



- Lights
- Electric devices
- Heating appliances
- other

Product specific safety information

- Electric connection:



Caution risk of electric shock

Among electric accessories there are: any lights, shaver plugs, switches with light point, heaters (heating resistors), exhaust fans, emergency call pull cords and others

- Heating (heat exchanger)

The heating must be connected to the central heating system.

- Supply and discharge piping

These must be executed in accordance with the legislation in force and the specific requirements of the project.

- Exhaust air

This must be connected to an approved air system that complies with the fire protection regulations.

Caution: To guarantee proper ventilation, a minimum gap between door and threshold of 1,5 cm must be kept clear. This is no longer the case when the door is equipped with an airing vent the size of which varies according to the quantity of air to be exhausted (see legal requirements).



The roof of the prefabricated bathroom is neither walkable, nor a plane to put objects on.

Transportation and storing on the building site

The bathrooms have to be checked immediately after arrival on site.. If any transport damages are evident, SANIKA has to be informed within the applicable legal terms, after which SANIKA will no longer be liable.

If necessary, the bathroom has to be protected from humidity with a water-resistant cover to be put on it either when it is still on the trailer or inside the building, the cover has to be fixed to the SANIKA prefabricated bathroom with adhesive tape or suited straps.

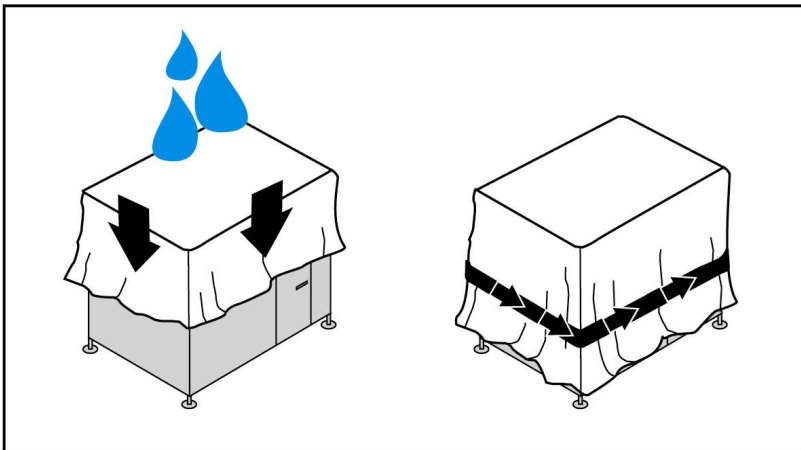

Once on site, the prefabricated bathroom must be moved by means of suited means of transportation.

The SANIKA prefabricated bathroom is suited to be transported with forklift or crane on the understanding that the following instructions are respected:

- Only trained personnel are allowed to control the crane and to drive the forklift.
- While handling the bathroom great attention must be paid not to damage sticking out parts (for example pipes, the shower waste under the pod, etc.)
- Keep to the site's regulations regarding the handling of heavy and overhead loads.
- Never exceed the maximum load of the lifting device and of the lifting equipment.
- Crane

The bathroom can be lifted by crane only using proper lifting equipment. Make use of a spreader beam with cross beams ("H" shaped) or a lifting frame in combination with steel beams (see picture below) or large lifting straps.

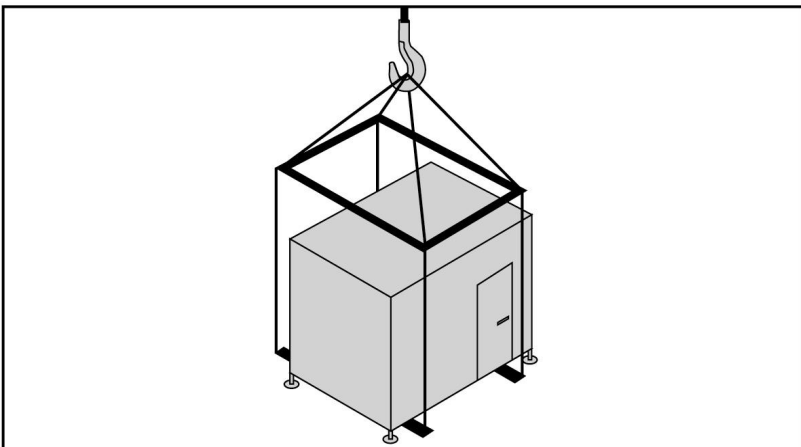

Caution: Never exceed the maximum load of the crane and of the lifting equipment (slings, chains, straps etc.).



Keep the bathroom horizontally while moving it.

Caution: Avoid diagonal pull of the straps. Doing that could compress and damage the bathroom pod.



Caution: The shift of the slings and/or the beams must be avoided by means of bands or other appliances.



- Handling inside the building

Caution: To handle the bathroom inside the building, where lifting by crane or forklift is not possible, use suited tools, like pallet trucks (see next chapter), wheels, trolleys etc.



- Forklift and pallet trucks

To lift the prefabricated bathroom make sure to employ long enough forks or approved extensions. Both must be longer than the bathroom pod itself, to guarantee a good support of the bathroom.

Caution: If indicated the prefabricated bathroom is only to be lifted with a forklift at the indicated points: see indication on bathroom.



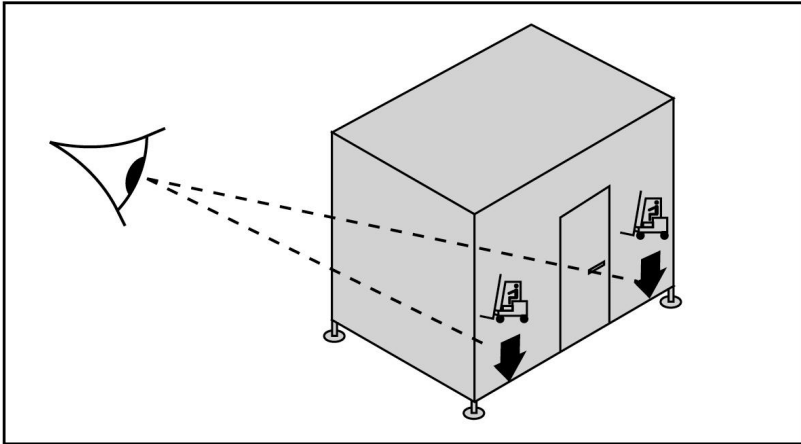

Caution: Always transport only one bathroom at a time with the forklift.



Never stack one bathroom on the other.

Do not exceed the maximum load of the forklift.

For any information please contact our distribution partner or directly our company.

Insertion of the bathroom pods in a building

The prefabricated bathrooms can be inserted in a building as follows:

- Slid into the building from the side using a loading bay with levelled entry to each floor;
- From above before casting or mounting the upper ceiling (this one especially in wooden constructions)
- Flat packed, i.e. disassembled in its components, through doors, staircases, windows or similar. For the assembly instructions of these bathroom pods please refer to the relevant chapter.

Caution:  The opening in the building must be bigger than the prefabricated bathroom or the component being inserted. The presence of installations on the ceiling or under the pod must be taken into account as well. The bathroom is usually delivered on wooden blocks to facilitate its handling.

Caution:  The loading bay must be suitable to carry the weight of the bathroom pod. Its dimensions must allow a free space of 0.5 m all around the bathroom cubicle. A balustrade must be provided to guarantee the health and safety of the fitters.

Caution:  The track to the definitive assembly position of the pod must be free from items and dirt; its width, its load capacity and the floor surface must guarantee a problem-free handling of the item.

Preparation of the assembly

Caution:  Please comply with the instructions below even if the assembly of the pod is carried out by SANIKA.

The area where the SANIKA bathroom pod is going to be positioned has to be as follows:

- The floor must be levelled.
- The levels indicated in the drawing must be observed if the bathroom has to be mounted flush to the finish floor level. No area must exceed the given tolerances.
- The load capacity of the floor has to support the weight of the bathroom pod, usually mounted on adjustable pedestals that cause point loads.

- Inside the building, the bathroom is usually moved by means of pallet trucks, wheels or trolleys. The tracks and the area where the bathroom is going to be positioned have to be suitable to carry the load of the wheels of such equipment. No soft floor covering (e.g. rubber sheets, insulation blankets or mats) must be laid out before the installation of the prefabricated bathroom as this would highly obstruct the handling of the pods.
- Agreed installations and preparatory works (e.g. installation of the soil and vent pipe, drilling of the core holes or similar) have to be performed before the insertion of the pods.

Set-up of a completely assembled bathroom

Caution: Follow the instructions in the chapter “Preparation of the assembly“!



Please read all of the assembly steps before starting to work, because it might be necessary to adjust their sequence in some particular cases!

The positioning differs only little between the SANIFLEX® (GRP bathrooms) and the SANICLASS® (tiled pods or similar) system. The specific instructions are given in the dedicated paragraphs. The following indications are general for both systems.

Caution: The horizontal installation of the bathroom is absolutely necessary to guarantee the functionality of the floor and shower drain.



Caution: Rubber pads have to be laid under each support point to warrant a good footfall sound insulation.



The requested level of the bathroom floor or threshold is reached by adjusting the screw jack pedestals or using different shims.

- SANICLASS® bathroom pod

Screw jack pedestals or shims are used to level the pod in accordance with the project requirements and the available space.

Put the adjustable pedestals or the shims with different thickness on the previously placed rubber pads in keeping with the positions indicated on the scheme (see bathroom drawing). Adjust their height with a laser and a measuring stick, taking into account the thickness of the bathroom floor. The supports should be screwed to the floor to facilitate the next steps.

Place the prefabricated bathroom on the supports paying attention not to move them. Make sure the pod is perfectly horizontal as described above and placed on the exact position.

- SANIFLEX® bathroom pod (GRP)

Take the bathroom to its final position.

The proper functionality of the prefabricated bathroom is guaranteed only if its installation is perfectly horizontal. This can be achieved setting the adjustable feet (when present) or using shims with different thickness.

Set-up of a provisionally pre-assembled bathroom (in elements)

Caution: Follow the instructions in the chapter “Preparation of the assembly“!



Please read all of the assembly steps before starting to work, because it might be necessary to adjust their sequence in some particular cases!

On customer's request, the prefabricated bathroom can also be delivered in pre-assembled elements to be definitely mounted only on site. All of the necessary materials and accessories are delivered together with the pod.

Caution: The assembly and the set-up of the prefabricated bathroom as well as the connection of electric supply, supply and discharge piping have to be made only by qualified personnel.



On site, remove the protective packaging material from the provisionally pre-assembled bathroom and unscrew it carefully into its easily transportable components as an alternative, the pod can be delivered flat packed on pallets.

On handling the elements, respect the following health and safety instructions:

- Do not damage any parts;
- Observe the regulation regarding the maximal lifting and handling of weights that a single person is allowed to carry.
- Pay attention not to loose any items.

Screw the preassembled discharge pipework to the shower waste.

Caution: Do not forget the gasket!



Mind the sticking out parts during each of the next assembling steps.

The shower trap must not be bear on the floor.

- SANICLASS® bathroom pod

The floor panel must be positioned according to the instructions of the chapter "Set-up of a completely assembled bathroom".

Clean the connection profiles from dust and grease. Plug the connecting clips in the channel of the floor profile. Apply an adhesive bead of MS polymer in the cove on the inside of the bathroom. Connect one wall panel after the other with the floor panel. The vertical profiles must be furnished with clips (female profile) and glue, too. Handles and vacuum cups facilitate the handling of the panels.

Repeat the just described sequence of steps for each wall panel.

If there is no access to the bathroom from outside, connect now the plumbing and other installations with the supply (see the relevant chapter).

This can be done before assembling all of the wall panels as well.

Lay the ceiling panel on the top of the bathroom and push it carefully into position. Avoid point-shaped loads!

- SANIFLEX® bathroom pod (GRP)

During the assembly process the bathroom must be accessible from all sides. For this reason usually it is not assembled in its final position, but close to it. Alternatively, the floor has to be positioned according to the instructions of the chapter “Set-up of a completely assembled bathroom”.

Clean the connecting flanges have and apply an end-to-end acetic silicone strip in the middle and remain on the inner side at the drill holes. Carefully, without smearing the silicone, set up one wall panel after the other and connect them with the provided screws. If the silicone spills out on the inside of the bathroom during this process, remove it with a cutter after it is completely cured.

Repeat the procedure for all of the wall panels.

The ceiling panel has to be laid on the top of the pod before the last wall panel.

The ceiling panel has to be fixed with chipboard screws.

Caution: Do not let the silicone dry! Tighten all screws immediately after the assembly of the wall panels.



Now fix the pipework and the other installation to the outside of the bathroom. After this, if the bathroom is not yet in its final position, follow the instructions in the chapter “Set-up of a completely assembled bathroom”,

- Installation of the bathroom furnishings

Only authorised personnel are allowed to install the bathroom furnishings. The applicable building regulations have to be observed.

Water connection

Only authorised personnel are allowed to connect the supply and discharge piping. The applicable building regulations have to be observed.

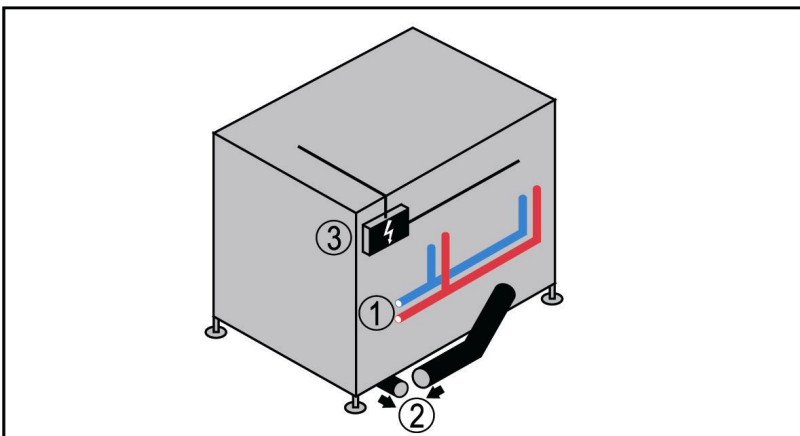

Hint: The exact positions of the connection vary from pod to pod, so please refer to the drawings.

Caution: All pipes have to be connected leak-proof. The manufacturer SANIKA is not liable for leaking connections.



Caution: The installation has to be tested and approved by a certified expert, although already tested during production..



Caution: The pipework of the building has to be flushed and free from dirt before connection of the pod. SANIKA is not going to take liability for obstructed or damaged components.



Caution: Observe the regulations regarding fire protection: where necessary wall and ceiling feedthroughs have to be partitioned.



- Supply of cold and hot water (pos. ①)

The connection point marked in red has to be connected to the hot water supply.

The second connection point has to be connected to the cold water supply.

Metallic fittings must be insulated with adhesive expanded rubber strips to prevent condensation.

The disinfection of the pipework of the bathroom, if requested by the regulations, has to be executed together with the installation of the whole building,. SANIKA does not do it in the factory.

- Discharge pipe (pos. ②)

All discharge piping of the prefabricated bathroom (bath, WC, shower and washbasin) has to be conducted to the soil and vent pipe. Check that this is done professionally.

Caution: In some cases the shower waste has to be connected with the soil and vent pipe on the lower floor. Please refer to the specific bathroom drawings!



- Heating pipes, if present

The connection point marked in red has to be connected to the flow.

The second connection point has to be connected to the return.

Observe the position on the installation drawings.

Ventilation

The air extraction pipe has to be connected to a central ventilation system as per building plan or to a duct leading to the open.

Caution: Observe the regulations regarding fire protection: where necessary wall and ceiling feedthroughs have to be partitioned.



Electric connection

The connection (pos. ③) has to be carried out by means of a junction box or a cable. The main supply has to satisfy the current regulations and the electric plan as well.

The connection to the electric supply has to be made by authorised personnel according to the EU-norm IEC 60364. They have to release a declaration of conformity of the electric installation. The earth bonding has to be connected. The appli-

cable regional and governmental building regulations and laws have to be observed.

Emergency pull cords or pushbuttons can be mounted in the bathroom. In case they are mounted in the shower or bathtub area (protection zone 1 or 2, extending till 225 cm from the floor), they need to be connected with a SELV or PELV circuit. The circuit of the emergency system of the bathroom pod might be connected to its own junction box. Please refer to the specific bathroom drawing!

Caution: Switch off power before connecting the electric supply



Caution: The electric connection has to be made according to the state of the art. The manufacturer SANIKA is not going to take liability for connections not matching the regulations.



Caution: The electric installation of the bathroom pod has to be connected to a high sensitive residual-current-operated protective device, RCD ($I \leq 30$ mA) in accordance to the local regulations and safety specifications.



Caution: An adequate protection for overvoltage and overcurrent has to be provided.



Conductors have to have the required minimum cross-sections and the following colours:

Earth bonding conductor: green/yellow

Neutral conductor: blue

Caution: Do not remove earthing points. If occasionally removed during maintenance, the earth cable has to be reconnected and tested in accordance with the regulations.



Caution: The electric installation has to be tested and approved by a certified expert, although already tested during production.



Caution: Observe the regulations regarding fire protection: where necessary wall and ceiling feedthroughs have to be partitioned.



Mounting of the outside cladding

Caution: The bathroom pod has to be checked to ensure full functionality and watertightness before the assembly of the outside lining. This is necessary to exclude transport damages and mistakes during the installation.



After the installation of the bathroom the outside cladding can be fixed in two different ways:

- by means of a self standing framework mounted around the bathroom.
- directly to the bathroom. This must be agreed with SANIKA in advance, in order to provide the pod with the apposite plasterboard rails.
- SANICLASS® bathroom pod

The outside cladding can be fixed directly to the prefabricated bathroom if its walls are free from piping or electrics. Otherwise, the lining has to be screwed to the apposite plasterboard rails. In both cases, the common screws for plasterboard assembly can be used.

The depth of the plasterboard rails, can be adjusted, if necessary, before fixing the cladding.

Caution: Under the plasterboard rails there may be piping or other installation. Do not use screws close to them!



Caution: It is forbidden to use screws or similar to fix the outside cladding to areas marked with sticky tape coloured black and yellow or red and white.



Caution: The length of the screws has to be chosen considering the panel thickness (50 mm) in order to prevent damages to the inside sheet metal.



- SANIFLEX® bathroom pod (GRP)

The outside lining must be screwed to the apposite plasterboard rails. It is forbidden to fix it directly to the wall panels.

The depth of the plasterboard rails, can be adjusted, if necessary, before fixing the cladding.

Caution: Under the plasterboard rails there may be piping or other installation.
Do not use screws close to them!



Installation of accessories

Light weight accessories, subject to little strain, can be fixed to the bathroom walls using a single-component PUR glue.

Caution: It is not allowed to install any hand rails, seats, grab rails or similar, unless the bathroom has been specifically arranged (please refer to the bathroom drawing)



The retrofitting of grab rails and wall mounted seats must be checked by Sanika and, if feasible, carried out by its technicians.

Caution: SANIKA disclaims all responsibility for the unauthorised retrofitting of accessories, inappropriate fixing and the potential loosening of an item with subsequent damages to people, things or the bathroom itself.



Caution: It is forbidden to retrofit electric devices.



SANICLASS® bathrooms (non GRP) offer an additional possibility. Light weight accessories, subject to little strain, can be fixed to the wall panels by means of their own plugs, if this is allowed by the wall finish (e.g. this is not possible on walls covered with glass panels).

Caution: It is not allowed to drill through wall panels (panel thickness 50 mm)!
Choose screws and plugs of the right length.



Drill a hole in the wall panel.

Caution: Choose the drilling bit according to the diameter of the plug.



The drilling bit has to be suitable to drill through the cladding and the sandwich panel.

Caution: There might be electric cables in the wall panel. Generally, the wiring is installed vertically or horizontally starting from the switch, socket or electric device.



Fill the drilled hole with a single-component PUR glue, push in the plug slowly and screw the accessory on it carefully

Caution: Tiles can break or be damaged when exposed to a point load.



Cleaning and care

Clean fittings, accessories and every other surface with neutral detergents and follow the specific producer's instructions.

Caution: It is not allowed to use corrosive chemical drain cleaners (go-devil) to clean waste pipes, because their plastic components could be damaged.



Caution: It is not allowed to remove blockages of drain pipes by means of compressed air.



Caution: Detergents containing abrasive substances, solvents, alcohol, acids or bases can damage the surfaces of the prefabricated bathroom and of its accessories.



The manufacturer SANIKA is not going to take liability for damages resulting from inappropriate cleaning of the prefabricated bathroom.

- SANICLASS® bathroom pod

SANICLASS® bathrooms can be equipped with different cladding materials (tiles, marble, glass, plaster, HPL, wood etc.). It is not possible to consider all different cases in this manual. Basically, all general advices listed at the beginning of this chapter are valid.

For more specific information, please contact our distribution partner or directly the producer.

- SANIFLEX® bathroom pod (GRP)

To reduce sediments and to make cleaning easier, the GRP parts of the SANIFLEX bathroom should be treated with a common car wax before the first use (follow the producer's instructions). Afterwards, the treatment should be repeated once a year.

Caution: Detergents containing acetone-based solvents or abrasive substances are not allowed. Parts made of glass fibre reinforced plastic must not be cleaned with strong bases (pH-value ≥ 10).



Periodic maintenance

The following list contains accessories installed frequently; maybe some components are not installed on your bathroom pod. Please refer to the applicable instructions below. With regard to the other accessories of the pod, please refer – if available – to their own user guide for additional, useful information.

- Drain of the shower or bathtub: clean the filter of the waste set and the trap.

Caution: This is especially important for a level entry shower, because water may spill out of the shower area.



- Shower head: remove the lime scale and check the shower hose
- Thermostatic mixers: check temperature and adjust the thermostatic cartridge (refer to the specific maintenance manual for the frequency of this action)
- Fan: clean or change of the filter
- Taps: clean the aerator
- Bathroom walls and accessories: keep clean

- Elastic joints: in case of discolouration (to yellow or black), cracking or dissolution, remove the joint carefully and replace it with waterproof sealant (e.g. acetic silicon sealant).
- Grout (SANICLASS® only): remove and replace in case of dissolution or heavy staining.
- Pilot lamp: check accumulators.

Repairs

- Any repair has to be carried out only by authorised engineers.
- Always use genuine parts as they are the only ones to satisfy technical standards and specifications. The use of non genuine parts does not ensure the optimal product safety and invalidates the product warranty.
- Always keep to the safety and maintenance instructions of the different accessories.
- Tiles (SANICLASS® bathrooms) can be removed by destroying them; the residual adhesive has to be removed mechanically paying great attention not to damage the support. New tiles can be glued on with a two-component adhesive. For further information or alternative products please refer directly to SANIKA.

Replacement of accessories: in its prefabricated bathrooms SANIKA fits only accessories complying with the national regulations. If the customer replaces an accessory, or part of, by his own, the warranty of SANIKA on that specific part expires. SANIKA advises to check with the supplier the conformity of the product and its warranty. Moreover, SANIKA recommends to commission the job directly to SANIKA or to an authorised technician.

Spare parts

If you need spare parts, please refer to the company SANIKA or to the dealer where you bought the bathroom giving the following data:

- The serial number of the bathroom that always begins with “SK” or “SKC” and can be found on a label under the wash-hand basin or on the delivery documents (delivery note and/or invoice).
- Description of the spare part and quantity required
- Method of delivery

Goods are always shipped “Ex-works” and freight charges are debited to the customer.

Warranty

5 years warranty on the floor, ceiling and wall elements, on material and production faults.

For everything else the current legislation on warranty applies.

In order to claim the warranty, the customer has to prove the date of purchase (i.e. with a copy of the invoice) and the name of the dealer he purchased the SANIKA bathroom from.

SANIKA makes available the faulty parts at its premises. Unless otherwise agreed in a written format, all freight and duty charges have to be paid by the customer.

Transport damages that might occur during the trip for the delivery of the bathroom are not covered by warranty if freight arrangements have not been made by SANIKA or when the damages have not been reported to SANIKA within the legally applying terms.

The warranty expires due to inappropriate use, modifications to the product an any other reason listed in this manual.

Manufacturer

SANIKA S.r.l.
Via Primo Maggio 22
38089 STORO TN
ITALY

Tel. +39 0465 680 146
Fax +39 0465 680 780
info@sanika.it
www.sanika.it

SANIKA



www.sanika.it

Rev. 03 - 07.10..2009